

# CD-203/DPF-R3010/DPF-R3010E CD-204/DPF-R4010/DPF-R4010E SERVICE MANUAL

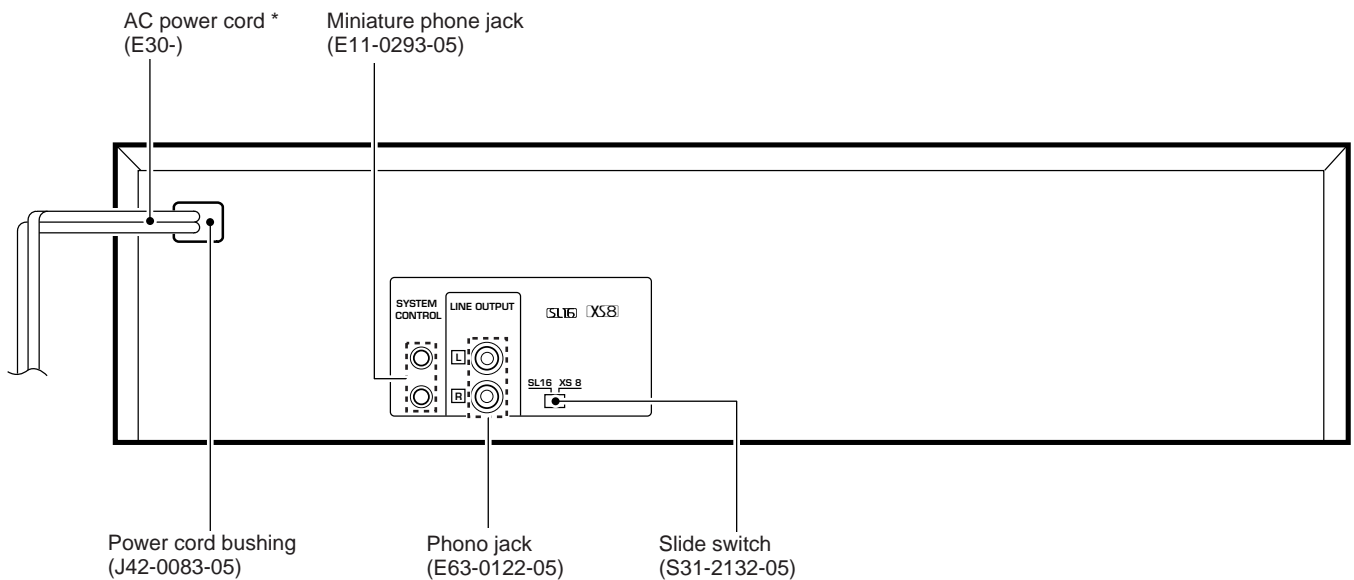
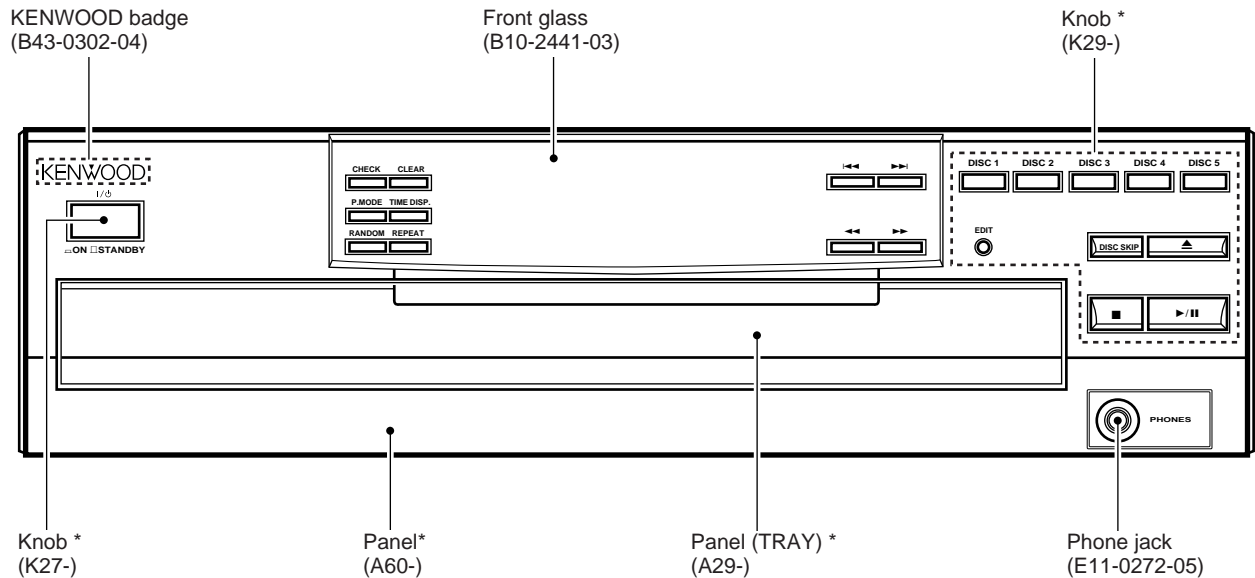

Illust is CD-204/DPF-R4010/DPF-R4010E.

\* Refer to parts list on page 16.

In compliance with Federal Regulations, following are reproductions of labels on, or inside the product relating to laser product safety.

KENWOOD-Crop. certifies this equipment conforms to DHHS Regulations No. 21 DFR 1040. 10, Chapter 1, Subchapter J.

**DANGER : Laser radiation when open and interlock defeated.  
AVOID DIRECT EXPOSURE TO BEAM**

Refer to 103CD/104CD/1050CD, DP-R797/R3090/R4090 (B51-5269-00) if you require circuit description and block diagram in detail.



## CONTENTS / ACCESSORIES

### Contents

CONTENTS / ACCESSORIES .....	2	SCHEMATIC DIAGRAM .....	9
CIRCUIT DESCRIPTION .....	3	EXPLODED VIEW .....	14
ADJUSTMENT .....	5	PARTS LIST .....	16
PC BOARD .....	6	SPECIFICATIONS .....	Back cover

### Accessories

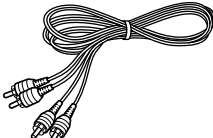
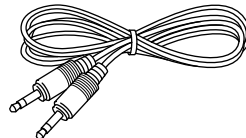
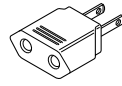
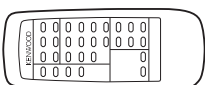
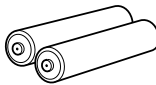
<p>Audio cord (1) (E30-0505-05)</p> 	<p>System control cord (1) (E30-2816-05)</p> 	<p>AC plug adapter (1) (E03-0115-05) DPF-R3010/R4010 : M type only</p> 
<p>Remote control unit (1) (A70-1128-05) : RC-P0504 CD-204/DPF-R4010/DPF-R4010E only</p> 	<p>Batteries (R6/AA) (2) CD-204/DPF-R4010/DPF-R4010E only</p> 	

Battery cover: (A09-0356-08)

### HOW TO READ THE PARTS LIST

#### ABBREVIATION OF MODEL AND MASS PRODUCTION'S DESTINATIONS

MODEL	ABB.	Australia	Canada	China	England	Europe	Germany	Korea	Malaysia
CD-203	-	-	P3	-	-	-	-	-	-
DPF-R3010	-	X3	-	-	T3	E3	-	-	-
DPF-R3010E	-	-	-	-	-	E4	-	-	-
CD-204	-	-	P1	-	-	-	-	-	-
DPF-R4010	-	X1	-	-	T1	E1	-	-	-
DPF-R4010E	-	-	-	-	-	E2	-	-	-

MODEL	ABB.	Mexico	PX/AAFES	Russia	Scandinavia	Shanghai	USA	Other area	
CD-203	-	-	-	-	-	-	K3	-	-
DPF-R3010	-	-	Y3	-	-	-	-	M3	-
DPF-R3010E	-	-	-	-	-	-	-	-	-
CD-204	-	-	-	-	-	-	K1	-	-
DPF-R4010	-	-	Y1	-	-	-	-	M1	-
DPF-R4010E	-	-	-	-	-	-	-	-	-

# CIRCUIT DESCRIPTION

## 1. Pin description

Pin No.	Name	I/O	Function	
1~7	7G~1G	O	Display digit control (Grid7~Grid1)	
8	VDD		Power supply (+5V)	
9	SQCK	O	Q data reading clock output	
10	NC	O	Unused	
11	SUBQ	I	Q data input	
12~15	KR3~KR0	I	Key return 3~0	
16	NC	I	Unused	
17	RESET	I	Reset input	L : RESET
18	SLT SW	I	CDM25 start limit switch input	L : SW ON
19	DOWN SW	I	CDM25 mechanism down switch input	L : SW ON
20	AVSS	I	Unused (connected to VSS)	
21	UP SW	I	CDM25 mechanism up switch input	L : SW ON
22	CLOSE SW	I	CDM25 close switch input	L : SW ON
23	OPEN SW	I	CDM25 open switch input	L : SW ON
24	OPEN M	O	Open motor control	H : ACTIVE
25	CLOSE M	O	Close motor control	H : ACTIVE
26	RTRAY R	O	Rotary tray motor control (CW)	H : ACTIVE
27	RTRAY L	O	Rotary tray motor control (CCW)	H : ACTIVE
28	RTRAY S	O	Rotary tray motor control (deceleration)	H : ACTIVE
29	AVDD		Unused (connected to VDD)	
30	AVREF		Unused (connected to VSS)	
31	NC	I	Unused	
32	XT2		Unused (OPEN)	
33	VSS		GND	
34	X1	I	System clock input	
35	X2		Unused	
36	DSENSE	I	CDM25 disc sensor detection	
37	PSENSE	I	CDM25 position sensor detection	
38	LDC	O	Laser signal output	L : LASER ON
39	FOK	I	FOK signal input	H : FOCUS ON
40	D.R.I.V.E	I	Unused	
41	SERIAL SW	I	Serial communication 8 (XS8)/16(SL16) bit changover	H : 16 BIT
42	SDATA	I/O	System serial data signal input output	
43	BUSY	I/O	System serial busy signal input output	
44	SCOR	I	Sub code frame sync detection	
45	MON	O	Focus drug countermeasure circuit control	
46	MUTG	O	Digital mute control	H : MUTE ON
47	REM	I	Remote control signal input	
48	VPP		GND	
49	SENSE	I	Sense input from CXD2507AQ	
50	DTA	O	Data output for CXD2507AQ	
51	CLK	O	Clock output for CXD2507AQ	
52	VDD		Power supply (+5V)	
53,54	DEFECT SEL./NC	I	Unused	
55	LAT	O	Latch output for CXD2507AQ	
56	GFS	I	Frame signal input	
57	RMUTE	O	Analog mute control	L : MUTE ON
58	MDT	O	Attenuater data output	
59	MCK	O	Attenuater clock output	
60	MEL	O	Attenuater latch output	
61~70	Sp~Sg/KS	O	Display segment control (Seg p~Seg g) / Key scan	
71	VLOAD		Display drive negative power supply (-35V)	
72~77	Sf~Sa/KS	O	Display segment control (Seg f~Seg a) / Key scan	
78~80	10G~8G	O	Display digit control (Grid10~Grid8)	

## CIRCUIT DESCRIPTION

### 2. Test mode

#### 2-1. Setting the test mode

- The microprocessor built in the unit can be put to TEST MODE by just pressing the TIME DISP. key when set to power on.
- DP-R series is available to set to each test mode by each key.

#### 2-2. Key vs Function in test mode

Step	Key name	Display	Description	
1	PLAY/PAUSE (Cyclic)	03	(1) Focus servo .....ON (2) Tracking servo .....OFF (3) Feed servo .....OFF	TE-B adjustment
		05	(1) Focus servo .....ON (2) Tracking servo .....ON (3) Feed servo .....ON	F-GAIN/T-GAIN FE-B adjustment
2	UP		Display goes on	
3	DOWN		Display goes off	
4	DISC1		Search the position of No. 1	
5	STOP	00	(1) Focus servo .....OFF (2) Tracking servo .....OFF (3) Feed servo .....OFF	Waiting key input
6	DISC2	-	Canceled Test mode	Normal mode
7	DISC3	01	Canceled Test mode, then 01 PLAY	Normal mode

# ADJUSTMENT

No.	ITEM	INPUT SETTINGS	OUTPUT SETTINGS	PLAYER SETTINGS	ALIGNMENT POINTS	ALIGN FOR	FIG.
<b>Open the tray (Normal mode), then turn the power off.</b>							
1	LASER POWER	—	Apply the sensor section of optical power meter on the pickup lens.	While pressing the TIME DISP. key, turn the AC ON. (Test mode) Press the PLAY/PAUSE key, then confirm that the display is "03".	—	On the power from 0.08 to 0.15 mW, when the diffraction grating is correctly aligned with the RF level of 1.0 Vp-p or more.	(a)
<b>1. Press the STOP key.</b> <b>2. Press the OPEN key.</b> <b>3. Load a disc, then press the CLOSE key.</b> <b>4. Press the PLAY key.</b> <b>5. Press the OPEN key to open the tray.</b> <b>6. Turn the power off. (Player stops as the tray is opened while the disc clamped.)</b> <b>7. While pressing the TIME DISP. key, turn the power ON to enter the Test mode.</b>							
2	TRACKING ERROR BALANCE	Test disc Type 4	Connect an oscilloscope as follows. CH1 : RF (CN2 pin 1) CH2 : TE1 (CN2 pin 6)	Press the PLAY/PAUSE key, then confirm that the display is "03".	TE BALANCE VR2	Symmetry between upper and lower patterns	
3	FOCUS ERROR BALANCE	Test disc Type 4	Connect an oscilloscope as follows. CH1 : RF (CN2 pin 1) CH2 : TE1 (CN2 pin 6)	Press the PLAY/PAUSE key, then confirm that the display is "05".	FE BALANCE VR1	Optimum eye pattern	
4	TRACKING GAIN	Test disc Type 4 Apply signal of 1.2 kHz, 50mVrms to CN2 pin 5-6.	Connect a LPF to CN2 pin 5-6 to which you connect an oscilloscope or AC voltmeters.	Press the PLAY/PAUSE key, then confirm that the display is "05".	TRACKING GAIN VR3	Two VTVMs should read the same value.	(e)

Note:  
 Type 4 disc : SONY YEDS-18 Test Disc or equivalent.  
 LPF: Around 47 kΩ+ 390 pF or so.  
 Step 1-4 are in Test Mode.

(a) Laser power

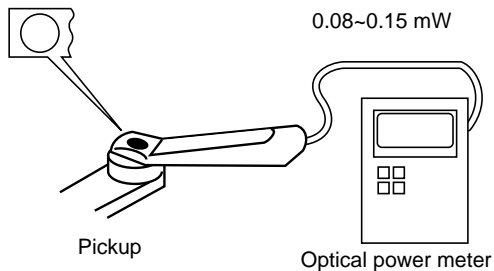

(e) Tracking gain

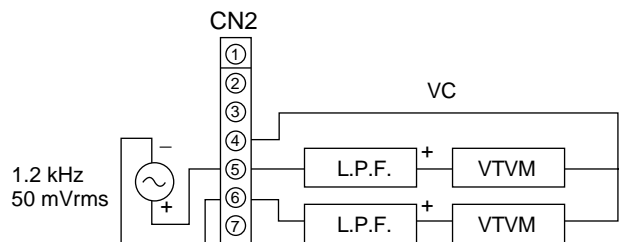

# PC BOARD (Component side view)

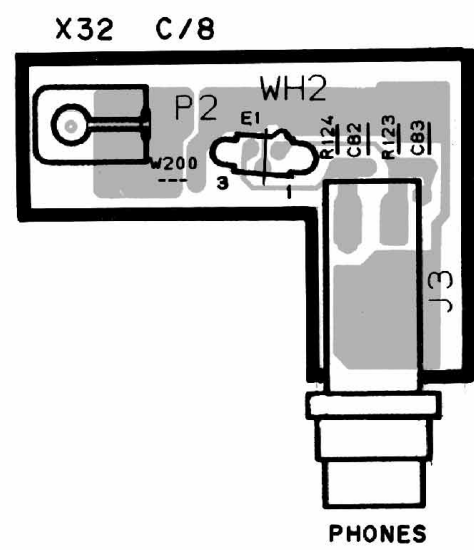
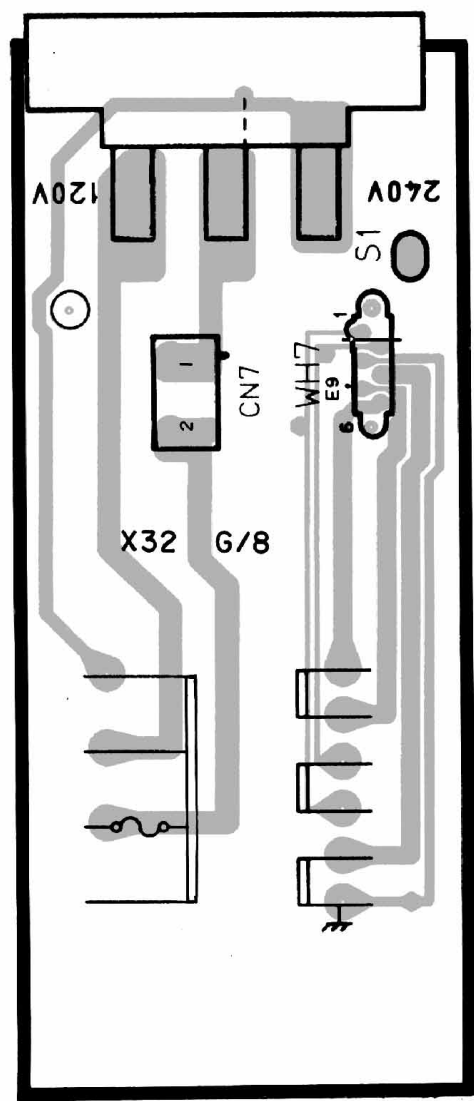
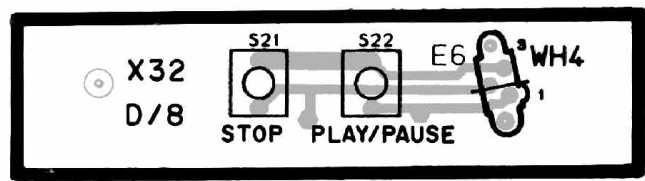
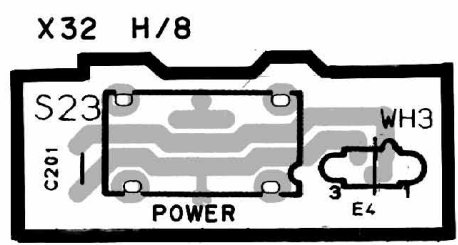
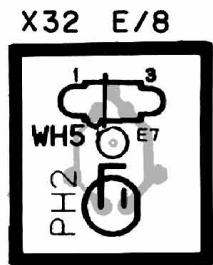
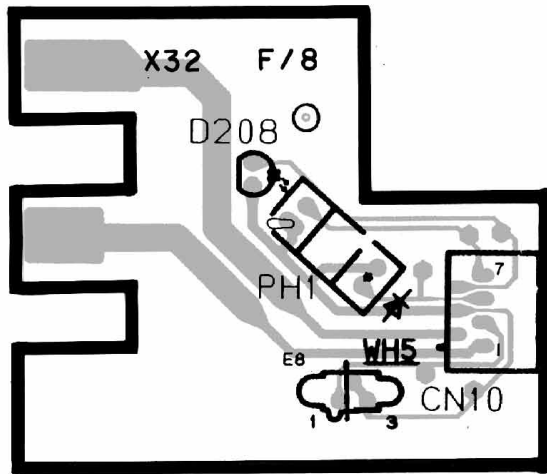

PHONES

Refer to the schematic diagram for the value of resistors and capacitors.



# PC BOARD(Component side view)

X32-363X-XX

0-10 : CD-204 (K,P)

0-22 : DPF-R3010 (Y,M)

2-72 : DPF-R3010 (X,T,E)

0-11 : CD-203 (K,P)

2-71 : DPF-R4010 (X,T,E)

DPF-R3010E (E2)

0-21 : DPF-R4010 (Y,M)

DPF-R4010E (E2)

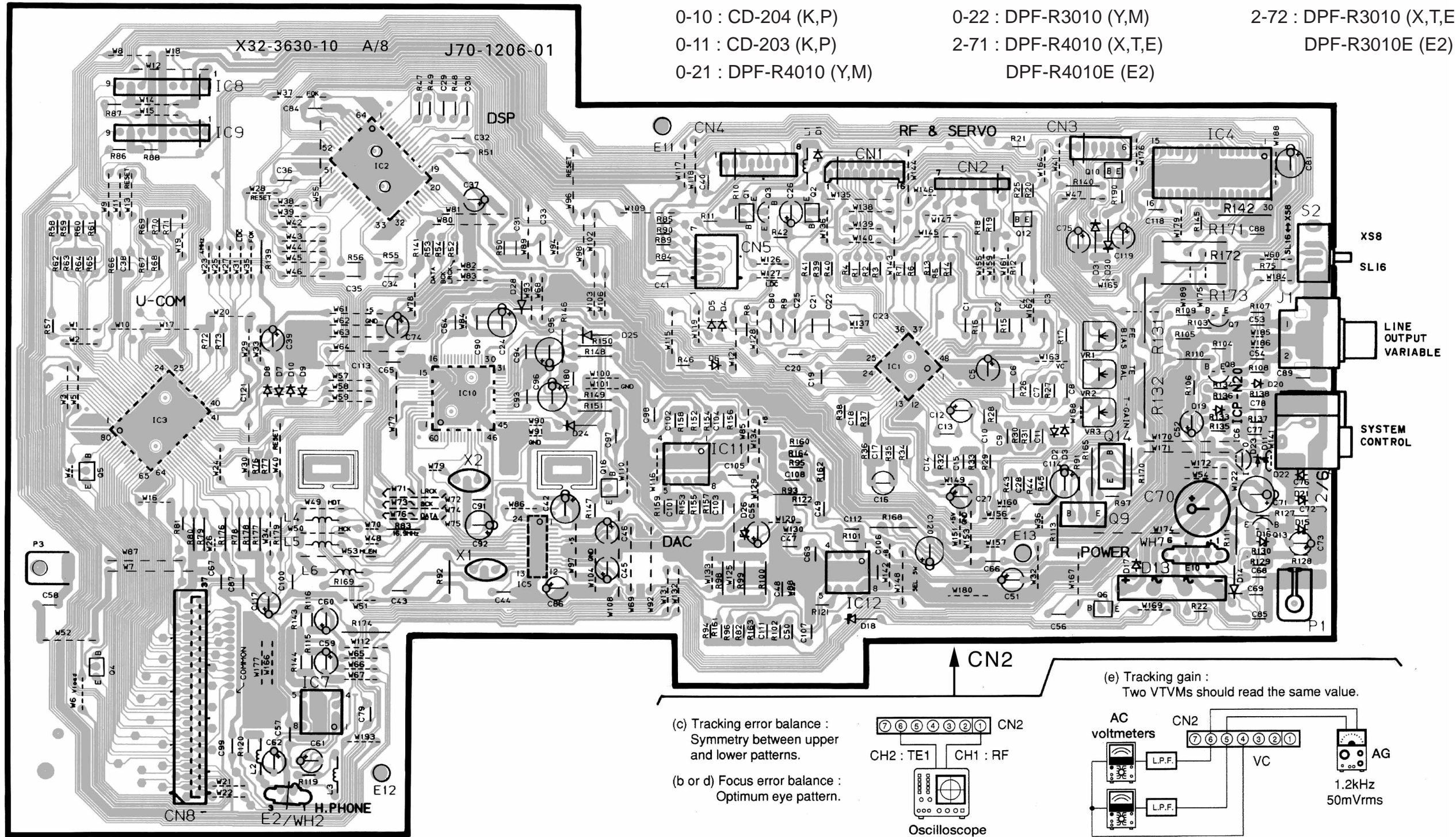

(c) Tracking error balance :  
Symmetry between upper  
and lower patterns.

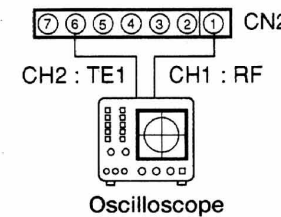

(b or d) Focus error balance :  
Optimum eye pattern.

(e) Tracking gain :  
Two VTVMs should read the same value.

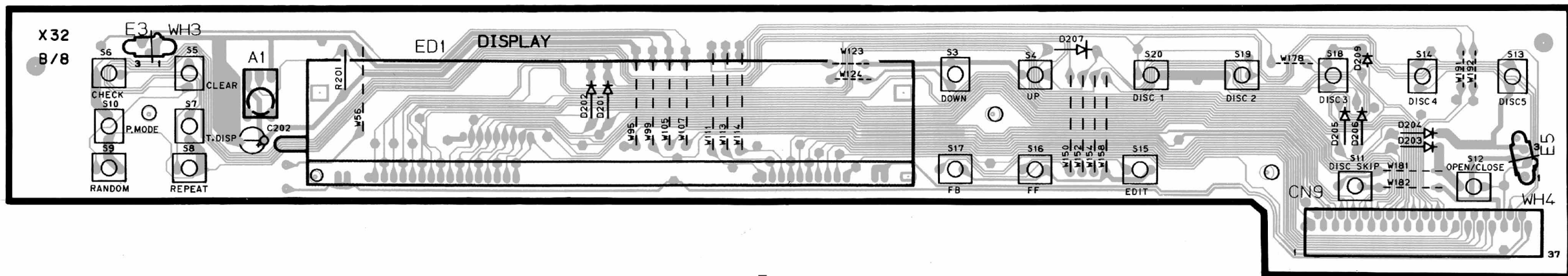
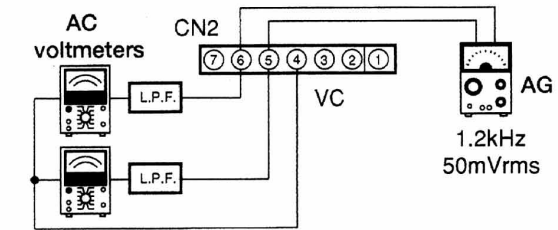

Refer to the schematic diagram for the value of resistors and capacitors.



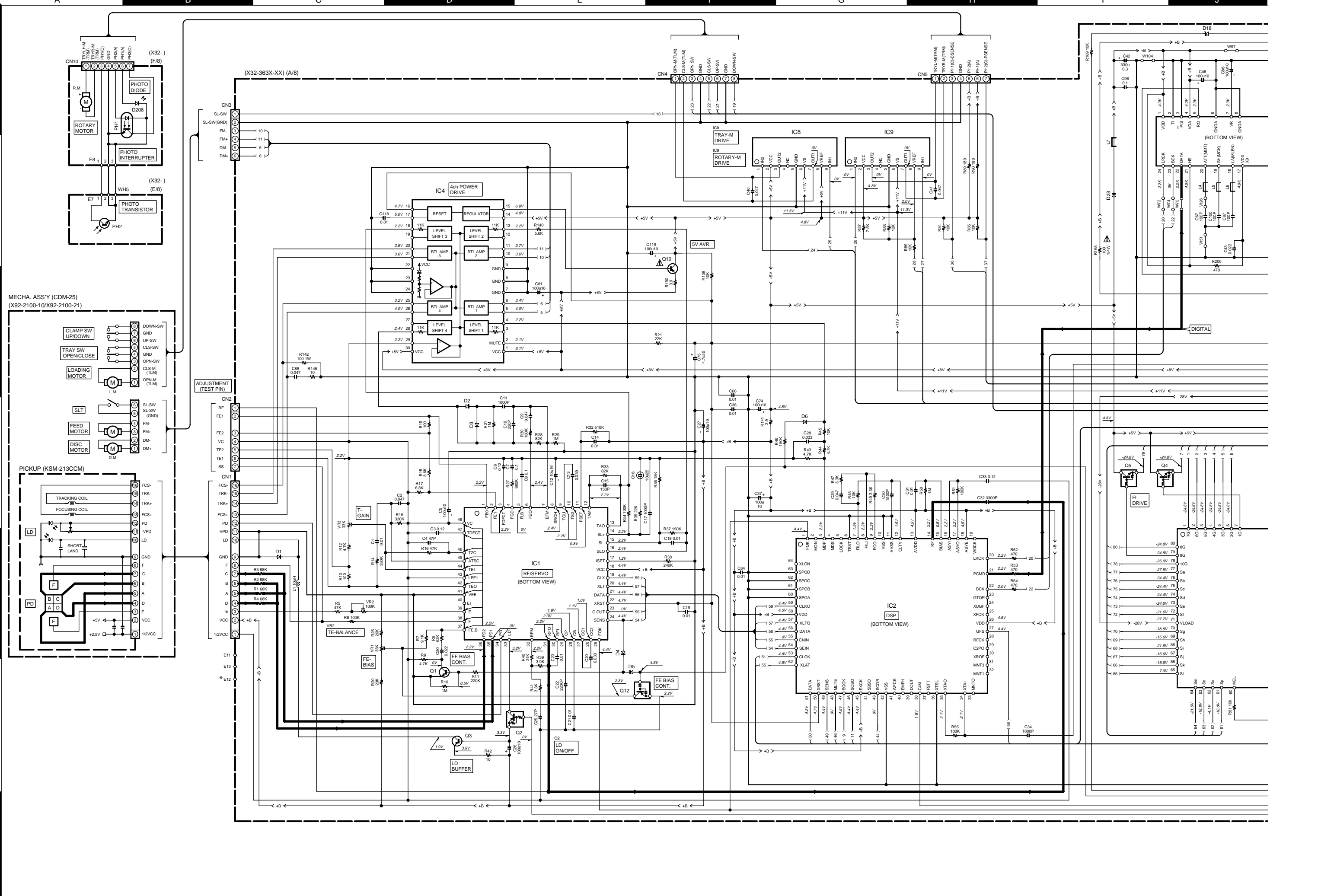



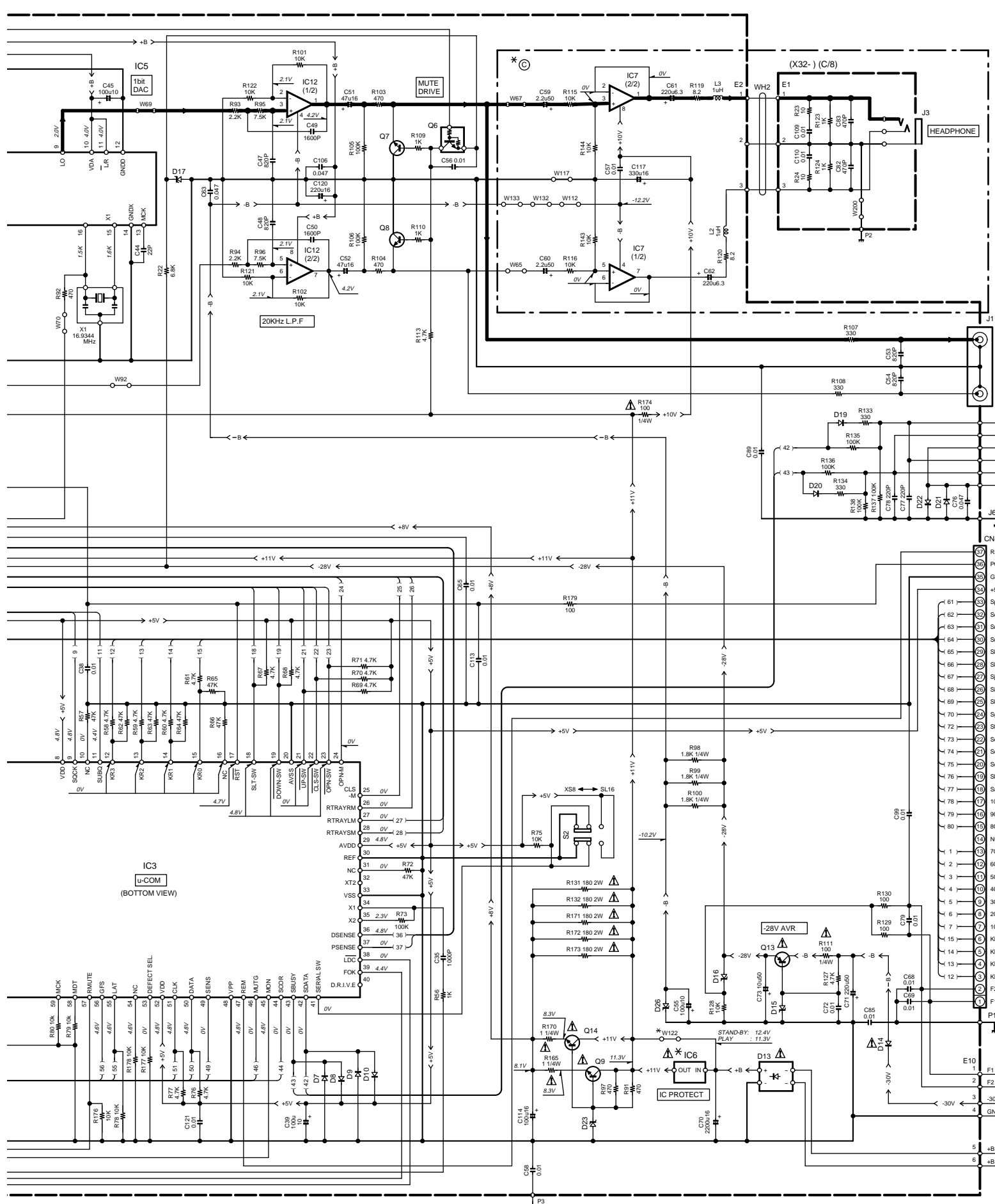

2SA1534A  
2SA954  
2SA992  
2SC2878

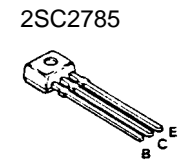

DTA124ESA  
DTC124ESA  
UN4112  
2SC1740S

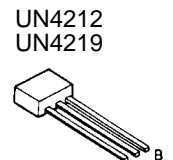

2SD2012

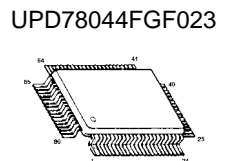
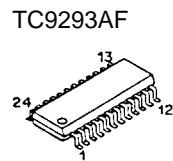
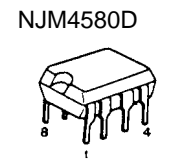
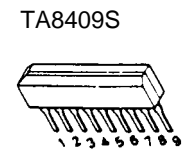
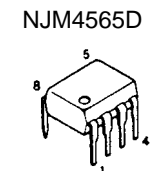
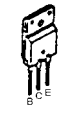

CD-203 (X32-3630-11)

DESTINATION	COUNTRY	ABB	UNIT No.	IC6	S1	E12	W122	W187
U.S.A.	K		0-11	NO	NO	NO	NO	YES
CANADA	P							

DPF-R3010(X32-363X-XX)

DESTINATION	COUNTRY	ABB	UNIT No.	IC6	S1	E12	W122	W187
U.S.A.	K		0-22	NO	YES	NO	NO	NO
AUSTRALIA	X							
U.K.	T		2-72	NO	NO	NO	NO	YES
EUROPE	E							

CD-204 (X32-3630-11)

DESTINATION	COUNTRY	ABB	UNIT No.	IC6	S1	E12	W122	W187
U.S.A.	K		0-10	YES	NO	NO	YES	YES
CANADA	P							

DPF-R4010(X32-363X-XX)

DESTINATION	COUNTRY	ABB	UNIT No.	IC6	S1	E12	W122	W187
U.S.A.	K		0-21	YES	YES	YES	NO	NO
AUSTRALIA	X							
U.K.	T		2-71	NO	NO	NO	NO	YES
EUROPE	E							

- IC1 : CXA1782BQ 1 \*
- IC2 : CXD2507AQ 1 \*
- IC3 : UPD78044FGF023
- IC4 : LA6541D
- IC5 : TC9293AF
- IC6 : ICP-N20
- IC7 : NJM4580D
- IC8,9 : TA8409S
- IC12 : NJM4565D
- Q1 : 2SC2785(F,E) or 2SC1740S(Q,R)
- Q2,12 : UN4112 or DTA124ESA
- Q3 : 2SA954(L,K)
- Q4,5 : UN4219 or DTC1132SA
- Q6 : UN4212 or DTC124ESA
- Q7,8 : 2SC2878(B)
- Q9,14 : 2SD2012
- Q10 : 2SA1534A
- Q13 : 2SA992(F,E)

- D1-10,19-22,28,201,207,209 : 1S133 or HSS104
- D13 : D3SBA20F03
- D14 : S5688B or 1SR139-400
- D15 : UZ-30BS or MTZJ30(B)
- D16,18 : UZ-5.6BSB or MTZJ5.6(B)
- D17 : UZ-4.7BSB or MTZJ4.7(B)
- D23 : UZ-8.2BSB or MTZJ8.2(B)
- D26 : UZ-10BSB or MTZJ10(B)
- D208 : SIR-335T3
- PH1 : T95-0145-05
- PH2 : RPT-38PT3F

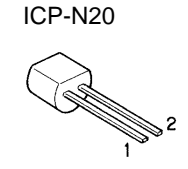
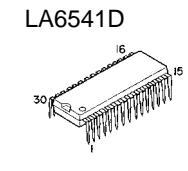
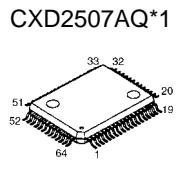
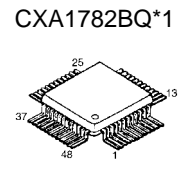

**CAUTION:** For continued safety, replace safety critical components only with manufacturer's recommended parts (refer to parts list).  $\Delta$  indicates safety critical components. For continued protection against risk of fire, replace only with same type and rating fuse(s). To reduce the risk of electric shock, leakage-current or resistance measurements shall be carried out (exposed parts are acceptably insulated from the supply circuit) before the appliance is returned to the customer.

The DC voltage is an actual reading measured with a high impedance type voltmeter. The measurement value may vary depending on the measuring instruments used or on the product. Refer to the voltage during PLAY unless otherwise specified; The value shown in ( ) is the voltage measured at the moment of STOP.

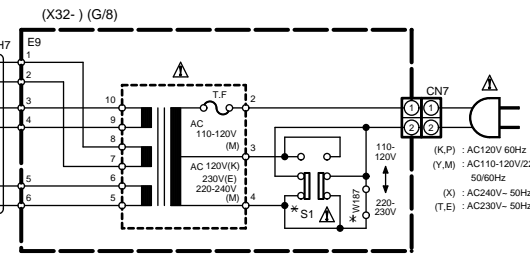

CD-203/204(K) (1/2)  
DPF-R3010/R4010(M) (1/2)

# CD-203/204/DPF-R3010/R3010E/R4010/R4010E

(X32-363X-XX) (B/8)

(X32-) (H/8)

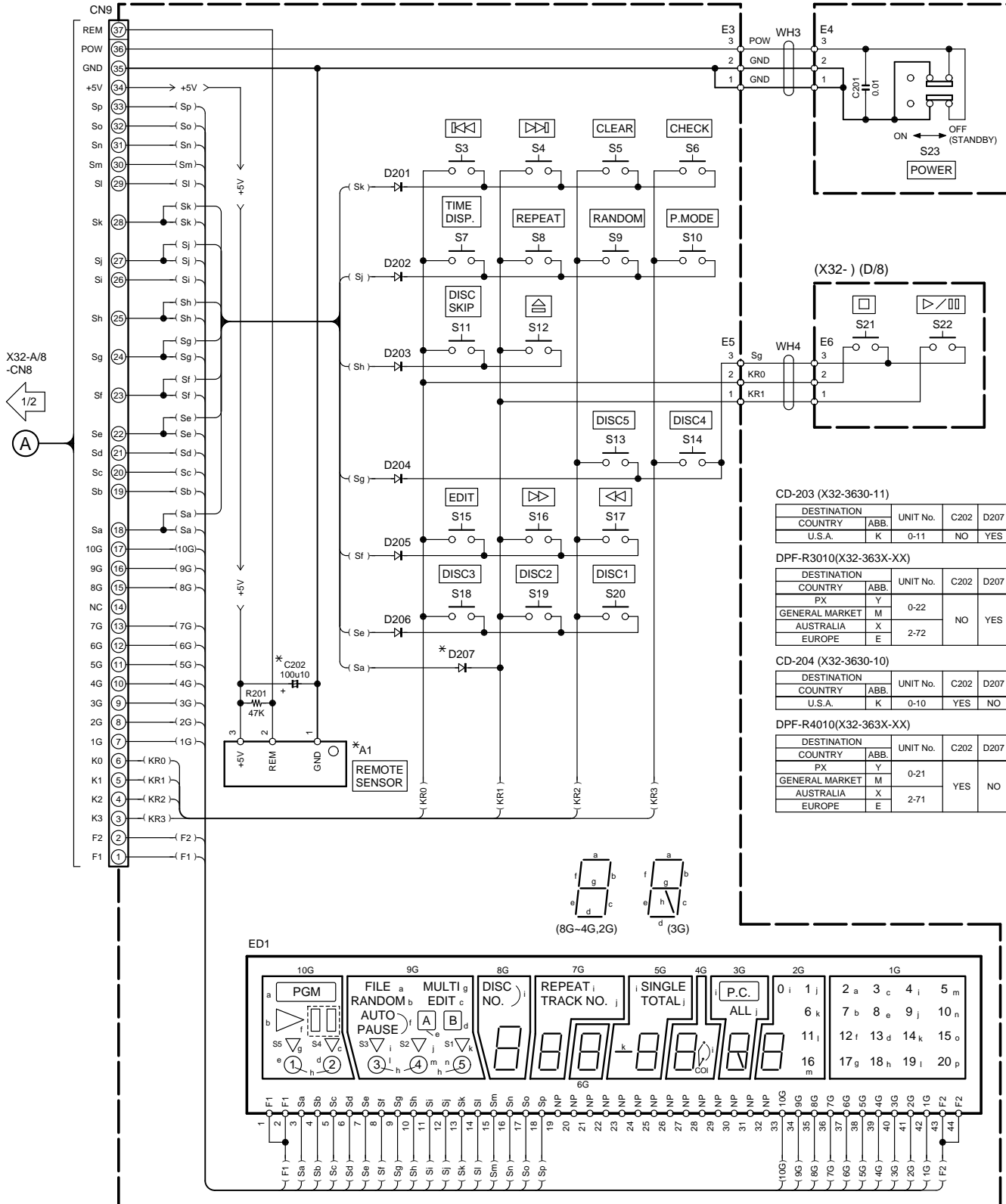

CD-203 (X32-3630-11)

DESTINATION	COUNTRY	ABB.	UNIT No.	C202	D207	A1
U.S.A.	K		0-11	NO	YES	NO

DPF-R3010(X32-363X-XX)

DESTINATION	COUNTRY	ABB.	UNIT No.	C202	D207	A1
PX	Y		0-22	NO	YES	NO
GENERAL MARKET	M					
AUSTRALIA	X		2-72			
EUROPE	E					

CD-204 (X32-3630-10)

DESTINATION	COUNTRY	ABB.	UNIT No.	C202	D207	A1
U.S.A.	K		0-10	YES	NO	YES

DPF-R4010(X32-363X-XX)

DESTINATION	COUNTRY	ABB.	UNIT No.	C202	D207	A1
PX	Y		0-21	YES	NO	YES
GENERAL MARKET	M					
AUSTRALIA	X		2-71			
EUROPE	E					

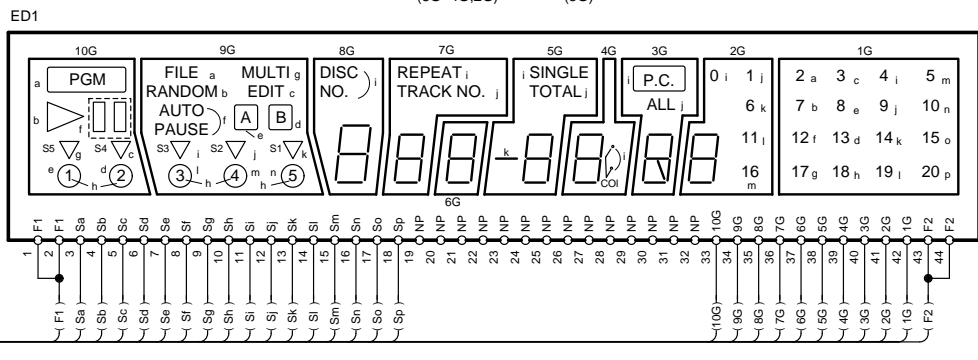
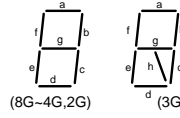

ED1 : 10-BT-131GK  
A1 : W02-2537-05

— GND LINE  
—<+B— +B LINE

CD-204/203(K) (2/2)  
DPF-R4010/R3010(M) (2/2)

CAUTION: For continued safety, replace safety critical components only with manufacturer's recommended parts (refer to parts list).  $\Delta$  indicates safety critical components. For continued protection against risk of fire, replace only with same type and rating fuse(s). To reduce the risk of electric shock, leakage-current or resistance measurements shall be carried out (exposed parts are acceptably insulated from the supply circuit) before the appliance is returned to the customer.

The DC voltage is an actual reading measured with a high impedance type voltmeter. The measurement value may vary depending on the measuring instruments used or on the product. Refer to the voltage during PLAY unless otherwise specified; The value shown in ( ) is the voltage measured at the moment of STOP.

# CD-203/204/DPF-R3010/R3010E/R4010/R4010E

Y22-7540-10

KENWOOD

EXPLODED VIEW (MECHANISM)

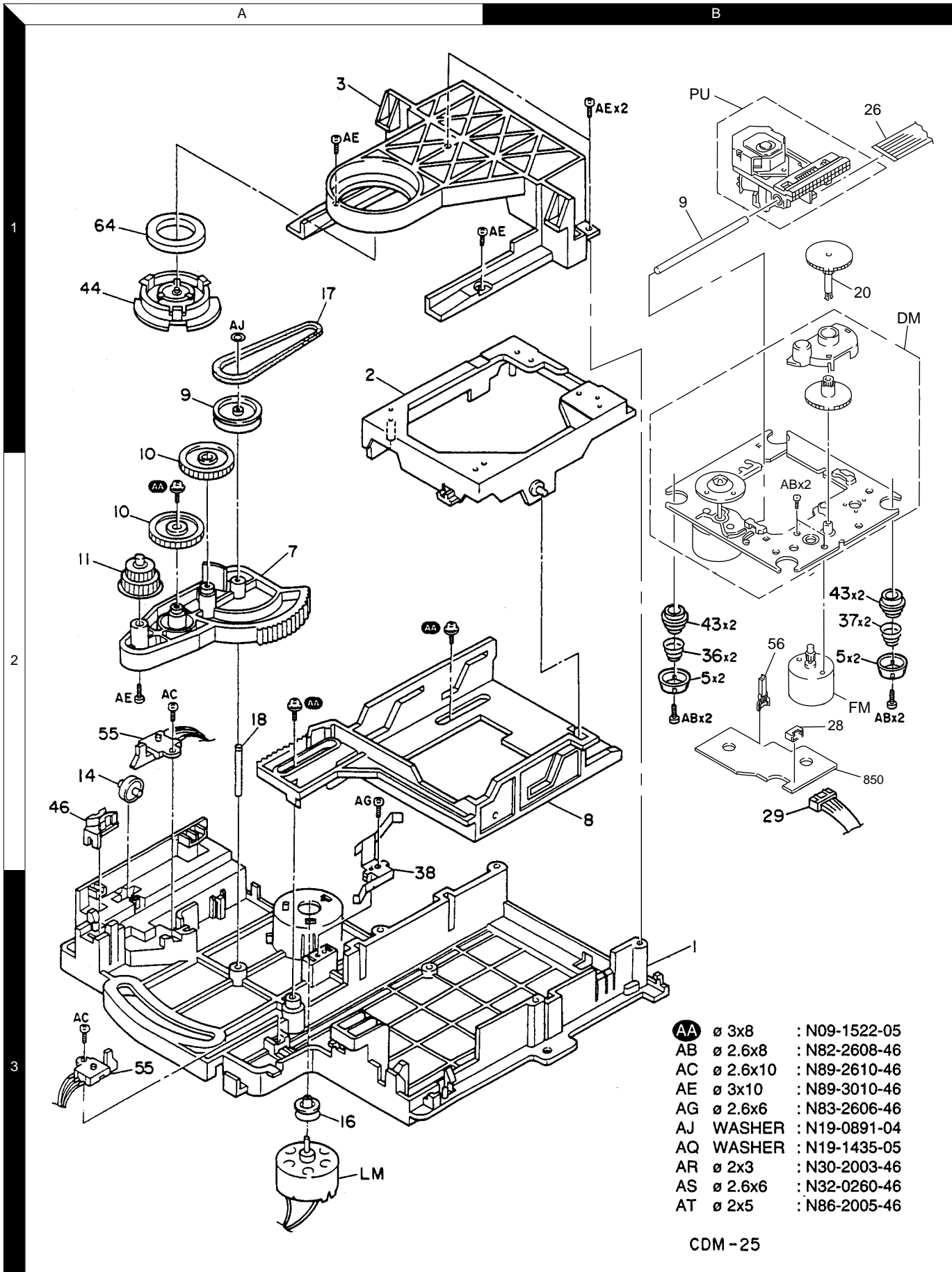

- AA  $\varnothing$  3x8 : N09-1522-05
- AB  $\varnothing$  2.6x8 : N82-2608-46
- AC  $\varnothing$  2.6x10 : N89-2610-46
- AE  $\varnothing$  3x10 : N89-3010-46
- AG  $\varnothing$  2.6x6 : N83-2606-46
- AJ WASHER : N19-0891-04
- AQ WASHER : N19-1435-05
- AR  $\varnothing$  2x3 : N30-2003-46
- AS  $\varnothing$  2.6x6 : N32-0260-46
- AT  $\varnothing$  2x5 : N86-2005-46

CDM-25

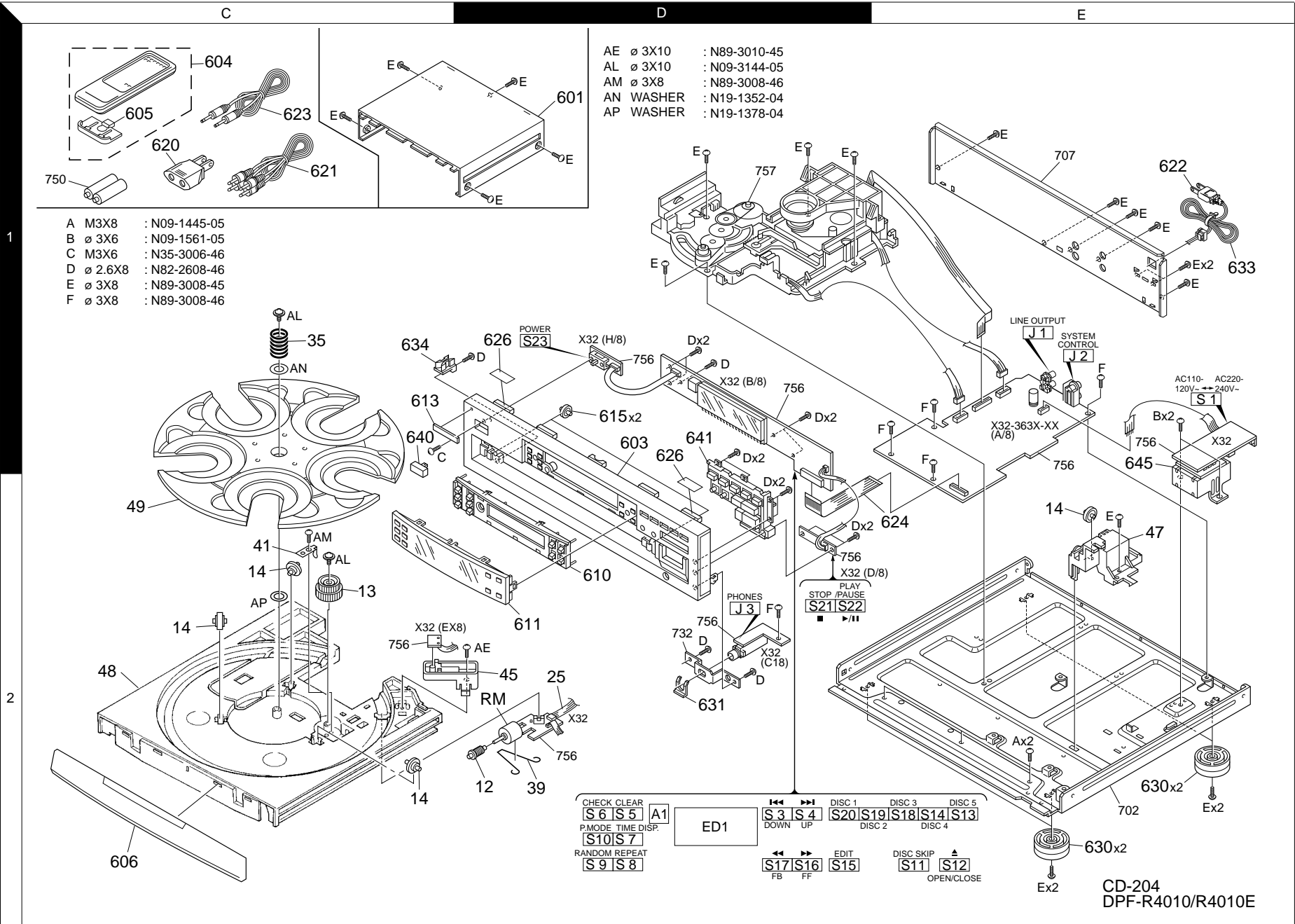

**EXPLODED VIEW (UNIT)**

CD-203/204/DPF-R3010/R3010E/R4010/R4010E

CD-204  
DPF-R4010/R4010E

\* New Parts  
Parts without **Parts No.** are not supplied.  
Les articles non mentionnés dans le **Parts No.** ne sont pas fournis.  
Teile ohne **Parts No.** werden nicht geliefert.

①

Ref. No	Address	New Parts	Parts No.	Description	Destination	Remarks
<b>CD-203/DPF-R3010/3010E/CD-204/DPF-4010/4010E</b>						
601	1D	*	A01-3547-01	METALLIC CABINET		
603	1D	*	A60-1348-21	PANEL	K1P1	
603	1D	*	A60-1349-21	PANEL	Y1	
603	1D	*	A60-1350-21	PANEL	K3P3	
603	1D	*	A60-1351-21	PANEL	Y3	
603	1D	*	A60-1460-21	PANEL	E1E2	
603	1D	*	A60-1460-21	PANEL	M1X1T1	
603	1D	*	A60-1461-21	PANEL	E3E4	
603	1D	*	A60-1461-21	PANEL	M3X3T3	
604	1C	*	A70-1128-05	REMOTE CONTROLLER(RC-P0504)	E1E2	
604	1C	*	A70-1128-05	REMOTE CONTROLLER(RC-P0504)	K1P1Y1	
604	1C	*	A70-1128-05	REMOTE CONTROLLER(RC-P0504)	M1X1T1	
605	1C	*	A09-0356-08	BATTERY COVER	E1E2	
605	1C	*	A09-0356-08	BATTERY COVER	K1P1Y1	
605	1C	*	A09-0356-08	BATTERY COVER	M1X1T1	
606	2C	*	A29-0895-12	PANEL	K1P1Y1	
606	2C	*	A29-0895-12	PANEL	K3P3Y3	
606	2C	*	A29-1013-12	PANEL	E1E2	
606	2C	*	A29-1013-12	PANEL	E3E4	
606	2C	*	A29-1013-12	PANEL	M1X1T1	
606	2C	*	A29-1013-12	PANEL	M3X3T3	
610	2D	*	B07-2404-12	ESCUTCHEON	K1P1Y1	
610	2D	*	B07-2404-12	ESCUTCHEON	K3P3Y3	
610	2D	*	B07-2417-12	ESCUTCHEON	E1E2	
610	2D	*	B07-2417-12	ESCUTCHEON	E3E4	
610	2D	*	B07-2417-12	ESCUTCHEON	M1X1T1	
610	2D	*	B07-2417-12	ESCUTCHEON	M3X3T3	
611	2D	*	B10-2441-03	FRONT GLASS		
613	2C	*	B43-0302-04	KENWOOD BADGE		
-	-	-	B46-0096-53	WARRANTY CARD	X1	
-	-	-	B46-0096-53	WARRANTY CARD	X3	
-	-	-	B46-0197-00	QUESTIONNAIRE CARD	K1	
-	-	-	B46-0197-00	QUESTIONNAIRE CARD	K3	
-	-	-	B46-0310-03	WARRANTY CARD	T1E1E2	
-	-	-	B46-0310-03	WARRANTY CARD	T3E3E4	
-	-	-	B46-0328-03	WARRANTY CARD	K1Y1	
-	-	-	B46-0328-03	WARRANTY CARD	K3Y3	
-	-	-	B46-0336-03	WARRANTY CARD	P1	
-	-	-	B46-0336-03	WARRANTY CARD	P3	
-	-	-	B58-0513-04	CAUTION CARD (PRESET220-240)	Y1	
-	-	-	B58-0513-04	CAUTION CARD (PRESET220-240)	Y3	
-	-	-	B58-0945-03	CAUTION CARD	T1	
-	-	-	B58-0945-03	CAUTION CARD	T3	
-	-	-	B58-0964-13	CAUTION CARD (UL)	K1Y1	
-	-	-	B58-0964-13	CAUTION CARD (UL)	K3Y3	
-	-	*	B58-0965-13	CAUTION CARD (T,XtypePL)	X1T1	
-	-	*	B58-0965-13	CAUTION CARD (T,XtypePL)	X3T3	
-	-	*	B58-0966-13	CAUTION CARD (ELMtypePL)	M1E1	
-	-	*	B58-0966-13	CAUTION CARD (ELMtypePL)	M3E3	
-	-	*	B58-0967-03	CAUTION CARD (PtypePL)	P1	
-	-	*	B58-0967-03	CAUTION CARD (PtypePL)	P3	
-	-	*	B58-1607-03	CAUTION CARD	E2E4	

L : Scandinavia K : USA P : Canada R : Mexico C : China I : Malaysia  
Y : PX(Far East, Hawaii) T : Europe E : Europe G : Germany V : China (Shanghai)  
Y : AAFES(Europe) X : Australia Q : Russia H : Korea M : Other Areas

△ indicates safety critical components.

\* New Parts  
Parts without **Parts No.** are not supplied.  
Les articles non mentionnés dans le **Parts No.** ne sont pas fournis.  
Teile ohne **Parts No.** werden nicht geliefert.

②

Ref. No	Address	New Parts	Parts No.	Description	Destination	Remarks
-	-	-	B59-1104-00	SERVICE DIRECTORY	Y1	
-	-	-	B59-1104-00	SERVICE DIRECTORY	Y3	
-	-	*	B60-3684-00	INSTRUCTION MANUAL(ENGLISH)	E2	
-	-	*	B60-3684-00	INSTRUCTION MANUAL(ENGLISH)	E4	
-	-	*	B60-3684-00	INSTRUCTION MANUAL(ENGLISH)	K1P1Y1	
-	-	*	B60-3684-00	INSTRUCTION MANUAL(ENGLISH)	K3P3Y3	
-	-	*	B60-3684-00	INSTRUCTION MANUAL(ENGLISH)	M1X1T1	
-	-	*	B60-3684-00	INSTRUCTION MANUAL(ENGLISH)	M3X3T3	
-	-	*	B60-3685-00	INSTRUCTION MANUAL(FRENCH)	P1E1	
-	-	*	B60-3685-00	INSTRUCTION MANUAL(G,D,I)	P3E3	
-	-	*	B60-3686-00	INSTRUCTION MANUAL(G,D,I)	E1	
-	-	*	B60-3686-00	INSTRUCTION MANUAL(G,D,I)	E3	
-	-	*	B60-3687-00	INSTRUCTION MANUAL(SPANISH)	M1E1	
-	-	*	B60-3687-00	INSTRUCTION MANUAL(SPANISH)	M3E3	
-	-	*	B60-3688-00	INSTRUCTION MANUAL(TAIWANESE)	M1	
-	-	*	B60-3688-00	INSTRUCTION MANUAL(TAIWANESE)	M3	
-	-	*	B60-3969-00	INSTRUCTION MANUAL(PH)	E2E4	
-	-	*	B60-3970-00	INSTRUCTION MANUAL(R)	E2E4	
-	-	*	B60-3971-00	INSTRUCTION MANUAL(CZ)	E2E4	
-	-	*	B60-3972-00	INSTRUCTION MANUAL(HG)	E2E4	
615	1D	-	D14-0389-04	ROLLER		
△ 620	1C	-	E03-0115-05	AC PLUG ADAPTER	M1	
△ 620	1C	-	E03-0115-05	AC PLUG ADAPTER	M3	
△ 621	1C	-	E30-0505-05	AUDIO CORD		
△ 622	1E	-	E30-2787-05	AC POWER CORD	K1P1	
△ 622	1E	-	E30-2787-05	AC POWER CORD	K3P3	
△ 622	1E	-	E30-2788-05	AC POWER CORD	M1E1E2	
△ 622	1E	-	E30-2788-05	AC POWER CORD	M3E3E4	
△ 622	1E	-	E30-2789-05	AC POWER CORD	Y1	
△ 622	1E	-	E30-2789-05	AC POWER CORD	Y3	
△ 622	1E	-	E30-2790-05	AC POWER CORD	X1	
△ 622	1E	-	E30-2790-05	AC POWER CORD	X3	
△ 622	1E	-	E30-2791-05	AC POWER CORD	T1	
△ 622	1E	-	E30-2791-05	AC POWER CORD	T3	
623	1C	-	E30-2816-05	CORD WITH PLUG		
624	2E	*	E35-2059-05	FLAT CABLE (37P)		
626	2D	-	G10-0444-04	NON-WOVEN FABRIC		
-	-	*	H10-7430-02	POLYSTYRENE FOAMED FIXTURE(L)	E2	
-	-	*	H10-7430-02	POLYSTYRENE FOAMED FIXTURE(L)	E4	
-	-	*	H10-7430-02	POLYSTYRENE FOAMED FIXTURE(L)	K1P1Y1	
-	-	*	H10-7430-02	POLYSTYRENE FOAMED FIXTURE(L)	K3P3Y3	
-	-	*	H10-7430-02	POLYSTYRENE FOAMED FIXTURE(L)	M1X1E1	
-	-	*	H10-7430-02	POLYSTYRENE FOAMED FIXTURE(L)	M3X3E3	
-	-	*	H10-7431-12	POLYSTYRENE FOAMED FIXTURE(R)	E2	
-	-	*	H10-7431-12	POLYSTYRENE FOAMED FIXTURE(R)	E4	
-	-	*	H10-7431-12	POLYSTYRENE FOAMED FIXTURE(R)	K1P1Y1	
-	-	*	H10-7431-12	POLYSTYRENE FOAMED FIXTURE(R)	K3P3Y3	
-	-	*	H10-7431-12	POLYSTYRENE FOAMED FIXTURE(R)	M1X1E1	
-	-	*	H10-7431-12	POLYSTYRENE FOAMED FIXTURE(R)	M3X3E3	
-	-	*	H10-7432-02	POLYSTYRENE FOAMED FIXTURE(L)	T1	
-	-	*	H10-7432-02	POLYSTYRENE FOAMED FIXTURE(L)	T3	
-	-	*	H10-7433-02	POLYSTYRENE FOAMED FIXTURE(R)	T1	

L : Scandinavia K : USA P : Canada R : Mexico C : China I : Malaysia  
Y : PX(Far East, Hawaii) T : Europe E : Europe G : Germany V : China (Shanghai)  
Y : AAFES(Europe) X : Australia Q : Russia H : Korea M : Other Areas

△ indicates safety critical components.

## PARTS LIST

CD-203/204/DPF-R3010/R3010E/R4010/R4010E



\* New Parts  
 Parts without **Parts No.** are not supplied.  
 Les articles non mentionnés dans le **Parts No.** ne sont pas fournis.  
 Teile ohne **Parts No.** werden nicht geliefert.



Ref. No	Add-ress	New Parts	Parts No.	Description	Desti-nation	Re-marks
			H10-7433-02	POLYSTYRENE FOAMED FIXTURE(R)	T3	
			H12-2339-04	PACKING FIXTURE		
			H13-0152-14	CARTON BOARD	X1	
			H13-0152-14	CARTON BOARD	X3	
			H13-0163-04	CARTON BOARD	T1	
			H13-0163-04	CARTON BOARD	T3	
			H20-0568-04	PROTECTION COVER	M1	
			H20-0568-04	PROTECTION COVER	M3	
			H21-0303-04	PROTECTION SHEET		
			H25-0232-04	PROTECTION BAG (235X350X0.03)	E2	
			H25-0232-04	PROTECTION BAG (235X350X0.03)	E4	
			H25-0232-04	PROTECTION BAG (235X350X0.03)	K1P1Y1	
			H25-0232-04	PROTECTION BAG (235X350X0.03)	K3P3Y3	
			H25-0232-04	PROTECTION BAG (235X350X0.03)	M1X1E1	
			H25-0232-04	PROTECTION BAG (235X350X0.03)	M3X3E3	
			H25-0651-04	PROTECTION BAG (0232 PRINT)	T1	
			H25-0651-04	PROTECTION BAG (0232 PRINT)	T3	
			H25-0661-04	PROTECTION BAG	E2	
			H25-0661-04	PROTECTION BAG	E4	
			H25-0661-04	PROTECTION BAG	K1P1Y1	
			H25-0661-04	PROTECTION BAG	K3P3Y3	
			H25-0661-04	PROTECTION BAG	X1T1E1	
			H25-0661-04	PROTECTION BAG	X3T3E3	
		*	H50-2776-04	ITEM CARTON CASE	Y1X1E1	
		*	H50-2777-04	ITEM CARTON CASE	M1	
		*	H50-2778-04	ITEM CARTON CASE	T1	
		*	H50-2779-04	ITEM CARTON CASE	K1P1	
		*	H50-2780-04	ITEM CARTON CASE	Y3X3E3	
		*	H50-2781-04	ITEM CARTON CASE	M3	
		*	H50-2782-04	ITEM CARTON CASE	T3	
		*	H50-2783-04	ITEM CARTON CASE	K3P3	
		*	H50-3069-04	ITEM CARTON CASE	E2	
		*	H50-3070-04	ITEM CARTON CASE	E4	
630	2E		J02-1167-03	FOOT	E1E2	
630	2E		J02-1167-03	FOOT	E3E4	
630	2E		J02-1167-03	FOOT	M1X1T1	
630	2E		J02-1167-03	FOOT	M3X3T3	
630	2E	*	J02-1405-03	FOOT (D=46,H=14.5,T)	K1P1Y1	
630	2E	*	J02-1405-03	FOOT (D=46,H=14.5,T)	K3P3Y3	
631	2D		J21-3326-05	JACK MOUNTING HARDWARE	E1E2	
631	2D		J21-3326-05	JACK MOUNTING HARDWARE	K1P1Y1	
631	2D		J21-3326-05	JACK MOUNTING HARDWARE	M1X1T1	
633	1E		J42-0083-05	POWER CORD BUSHING		
634	1C	*	J90-0851-04	GUIDE		
			J61-0307-05	WIRE BAND	T1E1E2	
			J61-0307-05	WIRE BAND	T3E3E4	
			J61-0307-05	WIRE BAND	Y1M1X1	
			J61-0307-05	WIRE BAND	Y3M3X3	
640	1C	*	K27-2258-04	KNOB (BUTTON) POWER	K1P1Y1	
640	1C	*	K27-2258-04	KNOB (BUTTON) POWER	K3P3Y3	
640	1C	*	K27-2295-04	KNOB (BUTTON) POWER	E1E2	
640	1C	*	K27-2295-04	KNOB (BUTTON) POWER	E3E4	
640	1C	*	K27-2295-04	KNOB (BUTTON) POWER	M1X1T1	
640	1C	*	K27-2295-04	KNOB (BUTTON) POWER	M3X3T3	

L : Scandinavia K : USA P : Canada R : Mexico C : China I : Malaysia  
 Y : PX(Far East, Hawaii) T : Europe E : Europe G : Germany V : China (Shanghai)  
 Y : AAFES(Europe) X : Australia Q : Russia H : Korea M : Other Areas

△ indicates safety critical components.

\* New Parts  
 Parts without **Parts No.** are not supplied.  
 Les articles non mentionnés dans le **Parts No.** ne sont pas fournis.  
 Teile ohne **Parts No.** werden nicht geliefert.



Ref. No	Add-ress	New Parts	Parts No.	Description	Desti-nation	Re-marks
641	1D	*	K29-6908-02	KNOB	K1P1Y1	
641	1D	*	K29-6908-02	KNOB	K3P3Y3	
641	1D	*	K29-7331-02	KNOB	E1E2	
641	1D	*	K29-7331-02	KNOB	E3E4	
641	1D	*	K29-7331-02	KNOB	M1X1T1	
641	1D	*	K29-7331-02	KNOB	M3X3T3	
△ 645	1E		L07-2297-05	POWER TRANSFORMER	K1P1	
△ 645	1E		L07-2297-05	POWER TRANSFORMER	K3P3	
△ 645	1E		L07-2298-05	POWER TRANSFORMER	E2	
△ 645	1E		L07-2298-05	POWER TRANSFORMER	E4	
△ 645	1E		L07-2298-05	POWER TRANSFORMER	X1T1E1	
△ 645	1E		L07-2298-05	POWER TRANSFORMER	X3T3E3	
△ 645	1E		L07-2299-05	POWER TRANSFORMER	Y1M1	
△ 645	1E		L07-2299-05	POWER TRANSFORMER	Y3M3	
<b>CD PLAYER UNIT (X32-363X-XX)</b>						
C1			CK45FF1H103Z	CERAMIC	0.010UF	Z
C2			CK45FF1H473Z	CERAMIC	0.047UF	Z
C3			CF92FV1H124J	MF-C	0.12UF	J
C4			CC45FSL1H470J	CERAMIC	47PF	J
C5			CE04LW1A101M	ELECTRO	100UF	10WV
C6			CF92FV1H124J	MF-C	0.12UF	J
C7 , 8			CQ93FMG1H104J	MYLAR	0.10UF	J
C9			CK45FF1H473Z	CERAMIC	0.047UF	Z
C10			CC45FSL1H221J	CERAMIC	220PF	J
C11			CK45FB1H102K	CERAMIC	1000PF	K
C12			CE04LW1C100M	ELECTRO	10UF	16WV
C13			CQ93FMG1H393J	MYLAR	0.039UF	J
C14			CK45FF1H103Z	CERAMIC	0.010UF	Z
C15			CC45FSL1H151J	CERAMIC	150PF	J
C16			CE04HW1E100M	NP-ELEC	10UF	25WV
C17			CK45FB1H102K	CERAMIC	1000PF	K
C18 , 19			CK45FF1H103Z	CERAMIC	0.010UF	Z
C20			CQ93FMG1H333J	MYLAR	0.033UF	J
C21			CK45FF1H103Z	CERAMIC	0.010UF	Z
C22			CK45FB1H222K	CERAMIC	2200PF	K
C23			CK45FF1H103Z	CERAMIC	0.010UF	Z
C25			CC45FSL1H180J	CERAMIC	18PF	J
C26 , 27			CE04LW1A101M	ELECTRO	100UF	10WV
C28			CQ93FMG1H333J	MYLAR	0.033UF	J
C29			CQ93FMG1H473J	MYLAR	0.047UF	J
C30			CK45FB1H152K	CERAMIC	1500PF	K
C31			CK45FF1H103Z	CERAMIC	0.010UF	Z
C32			CK45FB1H332K	CERAMIC	3300PF	K
C33			CF92FV1H124J	MF-C	0.12UF	J
C34 , 35			CK45FB1H102K	CERAMIC	1000PF	K
C36			CK45FF1H103Z	CERAMIC	0.010UF	Z
C37			CE04LW1A101M	ELECTRO	100UF	10WV
C38			CK45FF1H103Z	CERAMIC	0.010UF	Z
C39			CE04LW1A101M	ELECTRO	100UF	10WV
C40 , 41			CQ93FMG1H473J	MYLAR	0.047UF	J
C42			CE04LW0J331M	ELECTRO	330UF	6.3WV
C43			CK45FF1H223Z	CERAMIC	0.022UF	Z
C44			CC45FSL1H220J	CERAMIC	22PF	J
C45 , 46			CE04LW1A101M	ELECTRO	100UF	10WV

L : Scandinavia K : USA P : Canada R : Mexico C : China I : Malaysia  
 Y : PX(Far East, Hawaii) T : Europe E : Europe G : Germany V : China (Shanghai)  
 Y : AAFES(Europe) X : Australia Q : Russia H : Korea M : Other Areas

△ indicates safety critical components.

PARTS LIST

CD-203204/DPF-R3010/R3010E/R4010/R4010E

\* New Parts  
 Parts without **Parts No.** are not supplied.  
 Les articles non mentionnés dans le **Parts No.** ne sont pas fournis.  
 Teile ohne **Parts No.** werden nicht geliefert.

5

Ref. No	Add-ress	New Parts	Parts No.	Description	Desti-nation	Re-marks
C47 .48			CQ93FMG1H821J	MYLAR 820PF J		
C49 .50			CQ93FMG1H162J	MYLAR 1600PF J		
C51 .52			CE04LW1C470M	ELECTRO 47UF 16WV		
C53 .54			CQ93FMG1H821J	MYLAR 820PF J		
C55			CE04LW1A101M	ELECTRO 100UF 10WV		
C56			CK45FF1H103Z	CERAMIC 0.010UF Z		
C57			CK45FF1H103Z	CERAMIC 0.010UF Z	E1E2	
C57			CK45FF1H103Z	CERAMIC 0.010UF Z	K1P1Y1	
C57			CK45FF1H103Z	CERAMIC 0.010UF Z	M1X1T1	
C58			CK45FF1H103Z	CERAMIC 0.010UF Z		
C59 .60			CE04LW1H2R2M	ELECTRO 2.2UF 50WV	E1E2	
C59 .60			CE04LW1H2R2M	ELECTRO 2.2UF 50WV	K1P1Y1	
C59 .60			CE04LW1H2R2M	ELECTRO 2.2UF 50WV	M1X1T1	
C61 .62			CE04LW0J221M	ELECTRO 220UF 6.3WV	E1E2	
C61 .62			CE04LW0J221M	ELECTRO 220UF 6.3WV	K1P1Y1	
C61 .62			CE04LW0J221M	ELECTRO 220UF 6.3WV	M1X1T1	
C63			CK45FF1H473Z	CERAMIC 0.047UF Z		
C65 .66			CK45FF1H103Z	CERAMIC 0.010UF Z		
C67			CC45FSL1H101J	CERAMIC 100PF J		
C68 .69			CK45FF1H103Z	CERAMIC 0.010UF Z		
C70			CE04LW1C222M	ELECTRO 2200UF 16WV		
C71			CE04LW1H221M	ELECTRO 220UF 50WV		
C72			CK45FF1H103Z	CERAMIC 0.010UF Z		
C73			CE04LW1H100M	ELECTRO 10UF 50WV		
C74			CE04LW1A101M	ELECTRO 100UF 10WV		
C75			CE04LW1H4R7M	ELECTRO 4.7UF 50WV		
C76			CQ93FMG1H473J	MYLAR 0.047UF J		
C77 .78			CC45FSL1H221J	CERAMIC 220PF J		
C79			CK45FF1H103Z	CERAMIC 0.010UF Z		
C80			CK45FF1H223Z	CERAMIC 0.022UF Z		
C81			CE04LW1C101M	ELECTRO 100UF 16WV		
C82 .83			CQ93FMG1H471J	MYLAR 470PF J	E1E2	
C82 .83			CQ93FMG1H471J	MYLAR 470PF J	K1P1Y1	
C82 .83			CQ93FMG1H471J	MYLAR 470PF J	M1X1T1	
C84 .85			CK45FF1H103Z	CERAMIC 0.010UF Z		
C86			CE04LW1A101M	ELECTRO 100UF 10WV		
C87			CC45FSL1H101J	CERAMIC 100PF J		
C88			CK45FF1H473Z	CERAMIC 0.047UF Z		
C89			CK45FF1H103Z	CERAMIC 0.010UF Z		
C96			CQ93FMG1H104J	MYLAR 0.10UF J		
C99			CK45FF1H103Z	CERAMIC 0.010UF Z		
C100			CC45FSL1H101J	CERAMIC 100PF J		
C106			CK45FF1H473Z	CERAMIC 0.047UF Z		
C109,110			CK45FF1H103Z	CERAMIC 0.010UF Z	E1E2	
C109,110			CK45FF1H103Z	CERAMIC 0.010UF Z	K1P1Y1	
C109,110			CK45FF1H103Z	CERAMIC 0.010UF Z	M1X1T1	
C113			CK45FF1H103Z	CERAMIC 0.010UF Z		
C114			CE04LW1C101M	ELECTRO 100UF 16WV		
C117			CE04LW1C331M	ELECTRO 330UF 16WV	E1E2	
C117			CE04LW1C331M	ELECTRO 330UF 16WV	K1P1Y1	
C117			CE04LW1C331M	ELECTRO 330UF 16WV	M1X1T1	
C118			CK45FF1H103Z	CERAMIC 0.010UF Z		
C119			CE04LW1A101M	ELECTRO 100UF 10WV		
C120			CE04LW1C221M	ELECTRO 220UF 16WV		
C121			CK45FF1H103Z	CERAMIC 0.010UF Z		

L : Scandinavia K : USA P : Canada R : Mexico C : China I : Malaysia  
 Y : PX(Far East, Hawaii) T : Europe E : Europe G : Germany V : China (Shanghai)  
 Y : AAFES(Europe) X : Australia Q : Russia H : Korea M : Other Areas

Δ indicates safety critical components.

\* New Parts  
 Parts without **Parts No.** are not supplied.  
 Les articles non mentionnés dans le **Parts No.** ne sont pas fournis.  
 Teile ohne **Parts No.** werden nicht geliefert.

6

Ref. No	Add-ress	New Parts	Parts No.	Description	Desti-nation	Re-marks
C201			CK45FF1H103Z	CERAMIC 0.010UF Z		
C202			CE04LW1A101M	ELECTRO 100UF 10WV	E1E2	
C202			CE04LW1A101M	ELECTRO 100UF 10WV	K1P1Y1	
C202			CE04LW1A101M	ELECTRO 100UF 10WV	M1X1T1	
CN1			E40-8037-05	FLAT CABLE CONNECTOR		
CN2			E40-4876-05	PIN ASSY		
CN3			E40-3250-05	PIN ASSY		
CN4			E40-3252-05	PIN ASSY		
CN5			E40-4932-05	FLAT CABLE CONNECTOR		
CN7			E40-4245-05	PIN ASSY		
CN8			E40-4924-05	FLAT CABLE CONNECTOR		
CN9			E40-4962-05	FLAT CABLE CONNECTOR		
CN10			E40-4932-05	FLAT CABLE CONNECTOR		
J1			E63-0122-05	PHONO JACK		
J2			E11-0293-05	MINIATURE PHONE JACK(2P)		
J3			E11-0272-05	PHONE JACK	E1E2	
J3			E11-0272-05	PHONE JACK	K1P1Y1	
J3			E11-0272-05	PHONE JACK	M1X1T1	
-			J19-3647-14	HOLDER		
E11			J11-0808-05	WIRE CLAMPER		
E12			J11-0808-05	WIRE CLAMPER	E1E2	
E12			J11-0808-05	WIRE CLAMPER	K1P1Y1	
E12			J11-0808-05	WIRE CLAMPER	M1X1T1	
E13			J11-0808-05	WIRE CLAMPER		
L1			L40-1001-17	SMALL FIXED INDUCTOR(10UH,K)		
L2 .3			L40-1091-17	SMALL FIXED INDUCTOR	E1E2	
L2 .3			L40-1091-17	SMALL FIXED INDUCTOR	K1P1Y1	
L2 .3			L40-1091-17	SMALL FIXED INDUCTOR	M1X1T1	
L4 -6			L92-0018-05	FERRITE CORE		
L7			L92-0017-05	FERRITE CORE		
X1			L78-0299-05	RESONATOR (16.93M)		
Δ R111			RD14NB2E101J	RD 100 J 1/4W		
Δ R131,132			RS14KB3D181J	FL-PROOF RS 180 J 2W		
R142			RS14KB3A101J	FL-PROOF RS 100 J 1W		
Δ R165			RD14NB2E1R0J	RD 1 J 1/4W		
Δ R168			RD14NB2E101J	RD 100 J 1/4W		
Δ R170			RD14NB2E1R0J	RD 1 J 1/4W		
Δ R171-173			RS14KB3D181J	FL-PROOF RS 180 J 2W		
Δ R174			RD14NB2E101J	RD 100 J 1/4W		
VR1			R12-3687-05	TRIMMING POT.(33K)		
VR2			R12-5651-05	TRIMMING POT.(100K)		
VR3			R12-3687-05	TRIMMING POT.(33K)		
Δ S1			S31-2131-05	SLIDE SWITCH (POWER TYPE)	Y1M1	
Δ S1			S31-2131-05	SLIDE SWITCH (POWER TYPE)	Y3M3	
S2			S31-2132-05	SLIDE SWITCH		
S3 -22			S70-0031-05	TACT SWITCH		
S23			S40-2351-05	PUSH SWITCH		
PH1			T95-0145-05	OPTO ISOLATOR		
D1 -10			HSS104	DIODE		
D1 -10			1SS133	DIODE		
Δ D13			D3SBA20F03	DIODE		
Δ D14			S5688B	DIODE		

L : Scandinavia K : USA P : Canada R : Mexico C : China I : Malaysia  
 Y : PX(Far East, Hawaii) T : Europe E : Europe G : Germany V : China (Shanghai)  
 Y : AAFES(Europe) X : Australia Q : Russia H : Korea M : Other Areas

Δ indicates safety critical components.

PARTS LIST

CD-203/204/DPF-R3010/R3010E/R4010/R4010E

\* New Parts  
Parts without **Parts No.** are not supplied.  
Les articles non mentionnés dans le **Parts No.** ne sont pas fournis.  
Teile ohne **Parts No.** werden nicht geliefert.

7

Ref. No	Add-ress	New Parts	Parts No.	Description	Desti-nation	Re-marks
Δ D14			1SR139-400	DIODE		
D15			MTZJ30(B)	ZENER DIODE		
D15			UZ-30BS	ZENER DIODE		
D16			MTZJ5.6(B)	ZENER DIODE		
D16			UZ-5.6BSB	ZENER DIODE		
D17			MTZJ4.7(B)	ZENER DIODE		
D17			UZ-4.7BSB	ZENER DIODE		
D18			MTZJ5.6(B)	ZENER DIODE		
D18			UZ-5.6BSB	ZENER DIODE		
D19 -22			HSS104	DIODE		
D19 -22			1SS133	DIODE		
D23			MTZJ8.2(B)	ZENER DIODE		
D23			UZ-8.2BSB	ZENER DIODE		
D26			MTZJ10(B)	ZENER DIODE		
D26			UZ-10BSB	ZENER DIODE		
D28			HSS104	DIODE		
D28			1SS133	DIODE		
D201-206			HSS104	DIODE		
D201-206			1SS133	DIODE		
D207			HSS104	DIODE	E3E4	
D207			HSS104	DIODE	K3P3Y3	
D207			1SS133	DIODE	M3X3T3	
D207			1SS133	DIODE	E3E4	
D207			1SS133	DIODE	K3P3Y3	
D207			1SS133	DIODE	M3X3T3	
D208			SIR-33ST3	INFRARED LED		
ED1			10-BT-131GK	INDICATOR TUBE		
IC1			CXA1782BQ*1	ANALOGUE IC		
IC2			CXD2507AQ*1	MOS-IC		
IC3			UPD78044FGF023	MI-COM IC		
IC4			LA6541D	ANALOGUE IC		
IC5			TC9293AF	MOS-IC		
Δ IC6			ICP-N20	ANALOGUE IC	T1E1E2	
Δ IC6			ICP-N20	ANALOGUE IC	T3E3E4	
Δ IC6			ICP-N20	ANALOGUE IC	Y1M1X1	
Δ IC6			ICP-N20	ANALOGUE IC	Y3M3X3	
IC7			NJM4580D	IC(OP AMP X2)	E1E2	
IC7			NJM4580D	IC(OP AMP X2)	K1P1Y1	
IC7			NJM4580D	IC(OP AMP X2)	M1T1X1	
IC8 ,9			TA8409S	MOS-IC		
IC12			NJM4565D	ANALOGUE IC		
PH2			RPT-38PT3F	PHOTO TRANSISTOR		
Q1			2SC1740S(Q,R)	TRANSISTOR		
Q1			2SC2785(F,E)	TRANSISTOR		
Q2			DTA124ESA	DIGITAL TRANSISTOR		
Q2			UN4112	DIGITAL TRANSISTOR		
Q3			2SA954(L,K)	TRANSISTOR		
Q4 ,5			DTC113ZSA	DIGITAL TRANSISTOR		
Q4 ,5			UN4219	DIGITAL TRANSISTOR		
Q6			DTC124ESA	DIGITAL TRANSISTOR		
Q6			UN4212	DIGITAL TRANSISTOR		
Q7 ,8			2SC2878(B)	TRANSISTOR		
Q9			2SD2012	TRANSISTOR		
Δ Q10			2SA1534A	TRANSISTOR		
Δ Q12			DTA124ESA	DIGITAL TRANSISTOR		

L : Scandinavia K : USA P : Canada R : Mexico C : China I : Malaysia  
Y : PX(Far East, Hawaii) T : Europe E : Europe G : Germany V : China (Shanghai)  
Y : AAFES(Europe) X : Australia Q : Russia H : Korea M : Other Areas

Δ indicates safety critical components.

\* New Parts  
Parts without **Parts No.** are not supplied.  
Les articles non mentionnés dans le **Parts No.** ne sont pas fournis.  
Teile ohne **Parts No.** werden nicht geliefert.

8

Ref. No	Add-ress	New Parts	Parts No.	Description	Desti-nation	Re-marks
Q12			UN4112	DIGITAL TRANSISTOR		
Q13			2SA992(F,E)	TRANSISTOR		
Δ Q14			2SD2012	TRANSISTOR		
A1			W02-2537-05	ELECTRIC CIRCUIT MODULE	E1E2	
A1			W02-2537-05	ELECTRIC CIRCUIT MODULE	K1P1Y1	
A1			W02-2537-05	ELECTRIC CIRCUIT MODULE	M1X1T1	
<b>MECHANISM ASSY (X92-2100-21/X92-2120-10)</b>						
1	3B	*	A10-3360-01	CHASSIS		
2	1A	*	A11-1126-02	SUB CHASSIS		
3	1A	*	A11-1127-12	SUB CHASSIS		
5	2B	*	B09-0255-04	CAP		
7	2A	*	D10-3740-13	ARM		
8	2B	*	D10-3741-02	SLIDER		
9	1B	*	D13-1829-04	GEAR		
10	2A	*	D13-1830-14	GEAR		
11	2A	*	D13-1831-04	GEAR		
12	2D	*	D13-1833-04	WORM		
13	2C	*	D13-1832-04	GEAR		
14	2C,2E	*	D14-0389-04	ROLLER		
16	2A	*	D15-0407-04	MOTOR PULLEY		
17	1A	*	D16-0355-03	BELT		
18	2A	*	D21-1763-14	SHAFT		
19	1B	*	D10-3606-08	ROD		
20	1B	*	D13-1720-08	GEAR		
25	3D	*	E35-0747-25	FLAT CABLE (7P)		
26	1D	*	E35-1317-05	FLAT CABLE (16P)		
28	2B	*	E40-3264-05	PIN ASSY		
29	2B	*	E35-1669-05	WIRING HARNESS		
35	2C	*	G01-3630-14	COMPRESSION SPRING		
36	2B	*	G01-3753-04	COMPRESSION SPRING		
37	2B	*	G01-3754-04	COMPRESSION SPRING		
38	3A	*	G02-1049-04	FLAT SPRING		
39	3D	*	G09-0634-04	WIRE SPRING		
41	2D	*	G02-1631-04	FLAT SPRING		
-			G10-0146-04	NON-WOVEN FABRIC		
43	2B	*	J02-1121-04	INSULATOR		
44	1A	*	J11-0830-03	CLAMPER		
45	3D	*	J19-5818-04	HOLDER		
46	2A	*	J90-0851-04	GUIDE		
47	2E	*	J90-0852-02	GUIDE		
48	3C	*	J99-0801-01	TRAY		
49	2C	*	J99-0596-01	TRAY		
55	2A,3A	*	S33-2061-05	LEVER SWITCH		
56	2B	*	S74-0038-08	LEAF SWITCH		
64	1A	*	T99-0544-15	MAGNET		
DM	1B	*	A11-1082-08	DISC MOTOR ASSY		
FM	2B	*	T42-0817-08	FEED MOTOR		
LM	3A	*	T42-0524-05	DC MOTOR		
PU	1B	*	T25-0055-08	OPTICAL PICKUP HEAD		
RM	3D	*	T42-0670-15	DC MOTOR		

L : Scandinavia K : USA P : Canada R : Mexico C : China I : Malaysia  
Y : PX(Far East, Hawaii) T : Europe E : Europe G : Germany V : China (Shanghai)  
Y : AAFES(Europe) X : Australia Q : Russia H : Korea M : Other Areas

Δ indicates safety critical components.

PARTS LIST

CD-203204/DPF-R3010/R3010E/R4010/R4010E

## SPECIFICATIONS

### CD-204/203/DPF-R4010/3010

#### [ Format ]

System ..... Compact disc digital audio system  
Laser ..... Semiconductor laser

#### [ D/A Convertors ]

D/A Conversion ..... 1 Bit  
Oversampling ..... 8 fs (352.8 kHz)

#### [ Audio ]

Frequency response ..... 4 Hz – 20 kHz,  $\pm 0.5$  dB  
Signal to noise ratio ..... More than 95 dB  
Dynamic range ..... More than 95 dB  
Total harmonic distortion + noise

..... Less than 0.008% (at 1 kHz)

Wow & flutter ..... Unmeasurable Limit

#### Output level/impedance

Fixed (CD-203/DPF-R3010) ..... 2 V/0.8 k $\Omega$

Variable (CD-204/DPF-R4010) ..... (Max.) 2 V/0.3 k $\Omega$

#### Headphone output (Max.)

(CD-204/DPF-R4010 only) ..... 20 mW (32  $\Omega$ )

#### [ General ]

Power consumption ..... 13 W

Dimensions ..... W: 440 mm (17-5/16")

H: 125 mm (4-15/16")

D: 397 mm (15-5/8")

Weight (Net) ..... 5.0 kg (11.0 lb)



1. KENWOOD follows a policy of continuous advancements in development. For this reason specifications may be changed without notice.
2. The full performance may not be exhibited in an extremely cold location (under a water-freezing temperature).

#### Note:

Component and circuit are subject to modification to insure best operation under differing local conditions. This manual is based on Europe (E) standard, and provides information on regional circuit modification through use of alternate schematic diagrams, and information on regional component variations through use of parts list.

## KENWOOD CORPORATION

14-6, Dogenzaka 1-chome, Shibuya-ku, Tokyo, 150 Japan

### KENWOOD SERVICE CORPORATION

P.O. BOX 22745, 2201 East Dominguez St., Long Beach, CA 90801-5745, U.S.A.

### KENWOOD ELECTRONICS CANADA INC.

6070 Kestrel Road, Mississauga, Ontario, Canada L5T 1S8

### KENWOOD ELECTRONICS LATIN AMERICA S.A.

P.O. BOX 55-2791, Piso 6 plaza Chase, Cl. 47 y Aquilino de la Guardia Panama, Republic de Panama

### KENWOOD ELECTRONICS BRASIL LTDA.

Av Indianópolis, 628, 04062-001 Planalto Paullista São Paulo-SP-Brasil

### KENWOOD ELECTRONICS U.K. LIMITED

KENWOOD House, Dwight Road, Watford, Herts., WD1 8EB., United Kingdom

### KENWOOD ELECTRONICS BELGUM N.V.

Meachelsesteenweg 418, B-1930 Zaventem, Belgium

### KENWOOD ELECTRONICS DEUTSCHLAND GMBH

Rembrücker Str. 15, 63150 Heusenstamm, Germany

### KENWOOD ELECTRONICS FRANCE S.A.

13 Boulevard Ney, 75018 Paris, France

### KENWOOD ELECTRONICS ITALIA S.p.A.

Via G. Sirtori, 7/9 20129, Milano, Italy

### KENWOOD IBÉRICA S.A.

Bolivia, 239-08020 Barcelona, Spain

### KENWOOD ELECTRONICS AUSTRALIA PTY. LTD.

(A.C.N. 001499 074)

P.O. Box 504, 8 Figtree Drive, Australia Centre, Homebush, N.S.W. 2140, Australia

### KENWOOD & LEE ELECTRONICS, LTD.

Unit 3712-3724, Level 37, Tower 1, Metroplaza, 223 Hing Fong Road, Kwai Fong N.T., Hong Kong

### KENWOOD ELECTRONICS GULF FZE

P.O. Box 61318, Jebel Ali, Dubai, U.A.E.

### KENWOOD ELECTRONICS SINGAPORE PTE LTD.

No. 1 Genting Lane #02-02, KENWOOD Building, Singapore, 349544

### KENWOOD ELECTRONICS (MALAYSIA) SDN BHD.

#4.01 Level 4, Wisma Academy Lot 4A, Jalan 19/1 46300 Petaling Jaya Selangor Darul Ehsan Malaysia

### KENWOOD ELECTRONICS (THAILAND) CO., LTD.

573/111 Soi Ramkhamhaeng 39, Ramkhamhaeng Road, Wangthonglang, Bangkok, Bangkok 10301 Thailand